

Artemide®

Calipso

design
N. Poulton

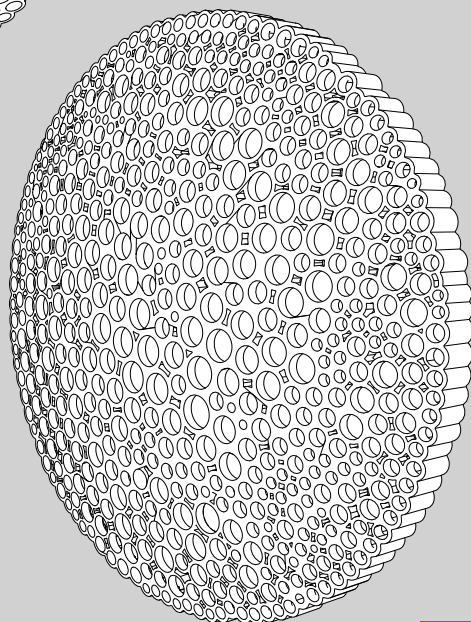

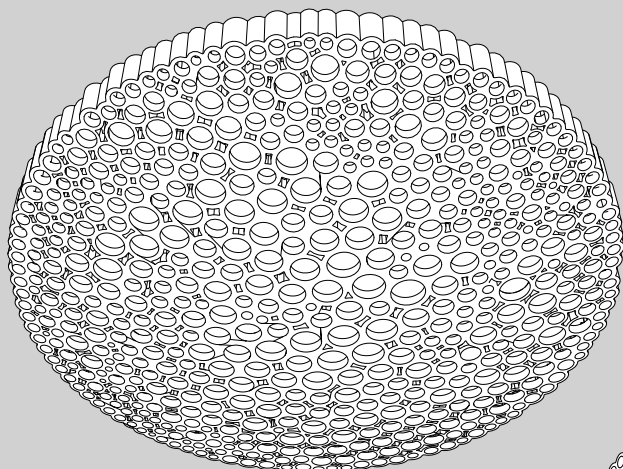

i

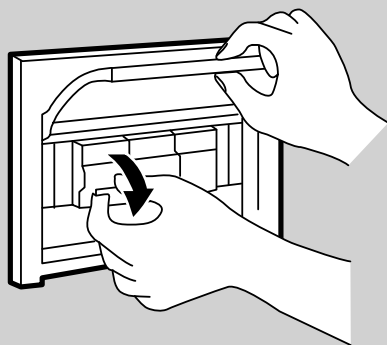
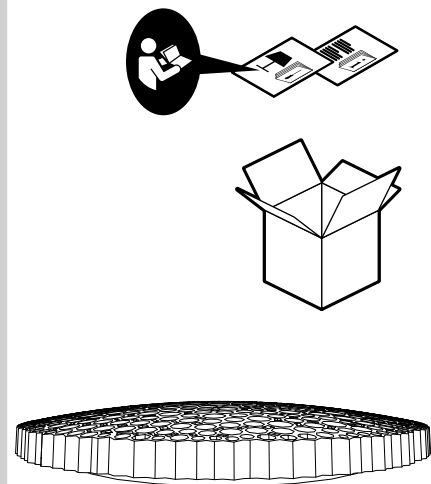
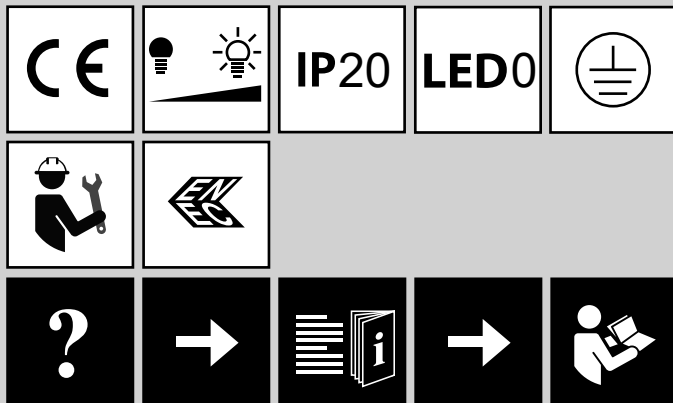

1

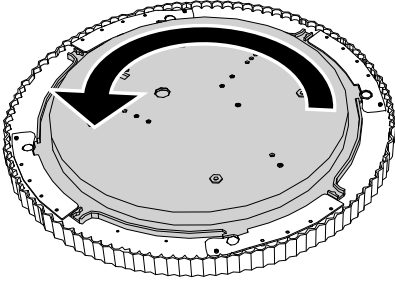

2

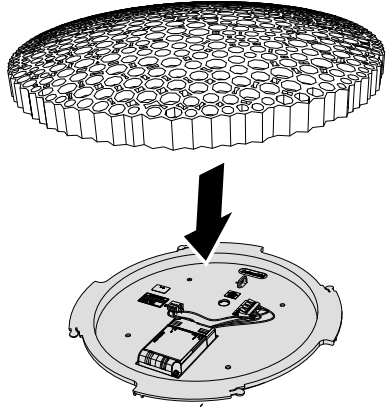

i

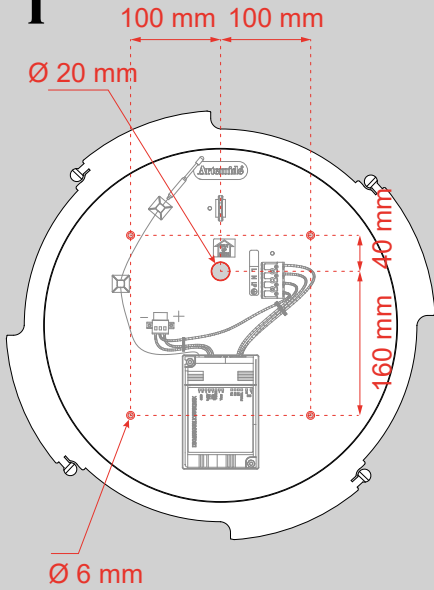

3

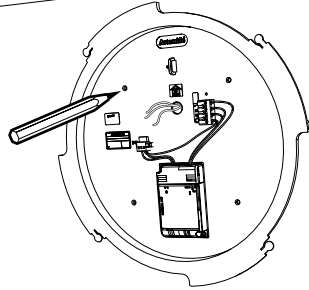

4

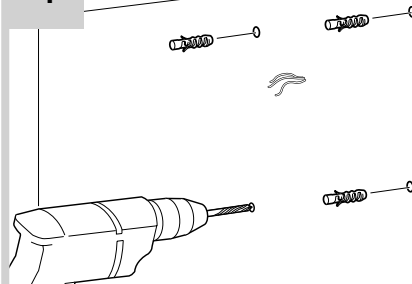

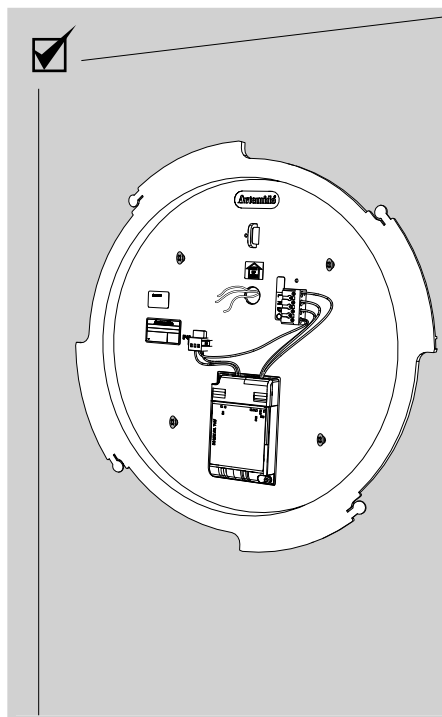
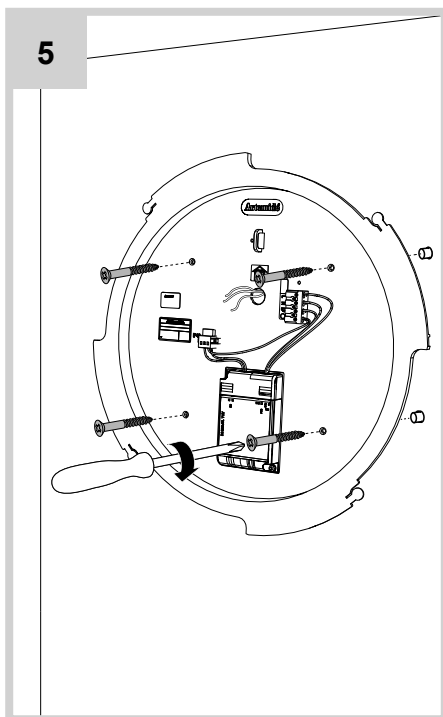
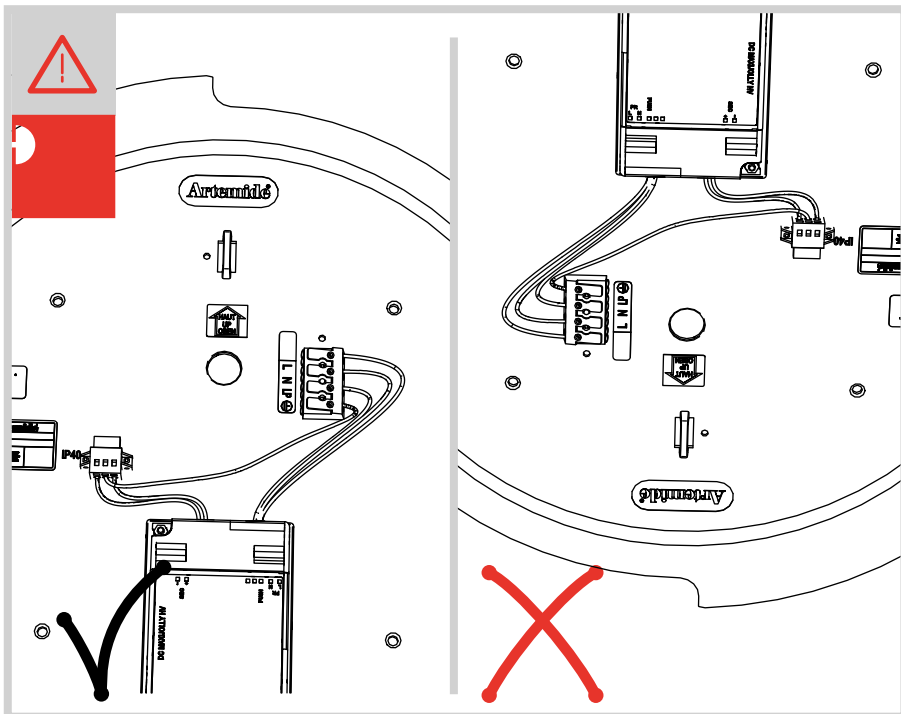

6a

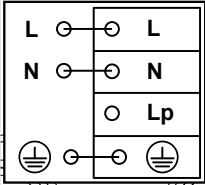
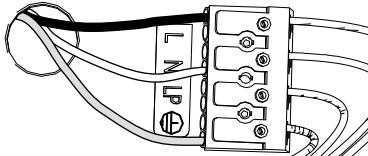

6b

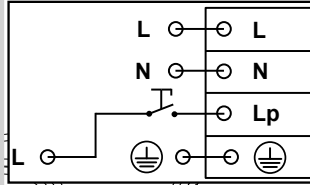
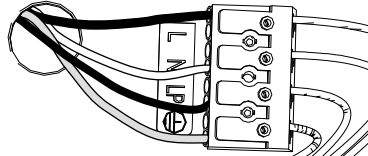

7

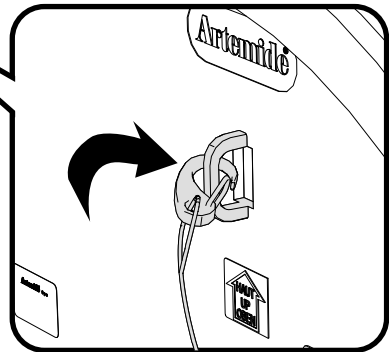
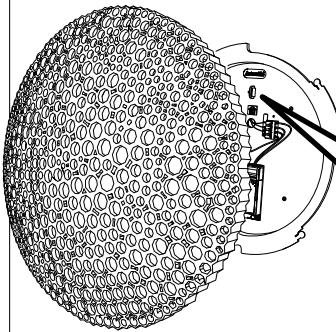

8

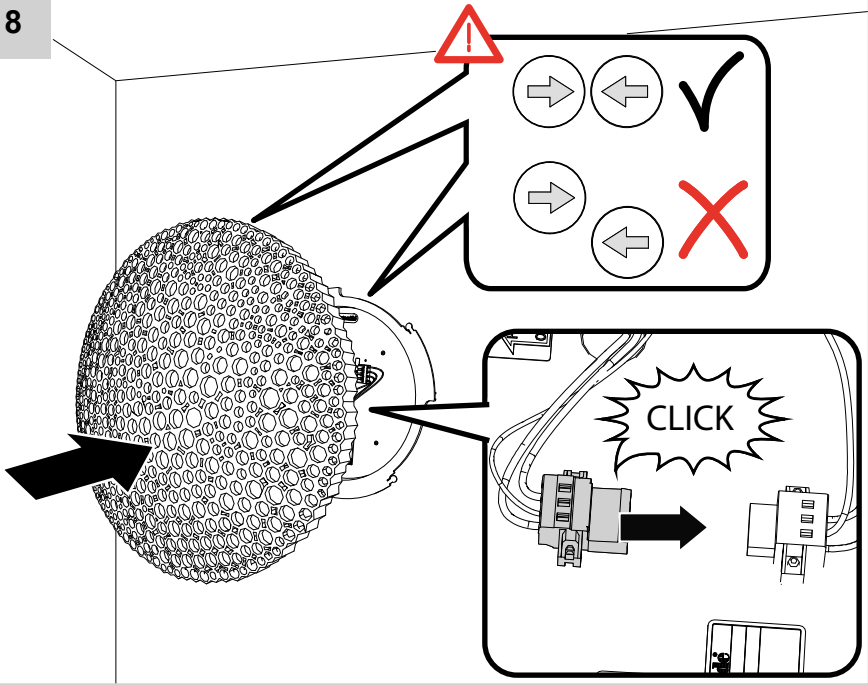

9

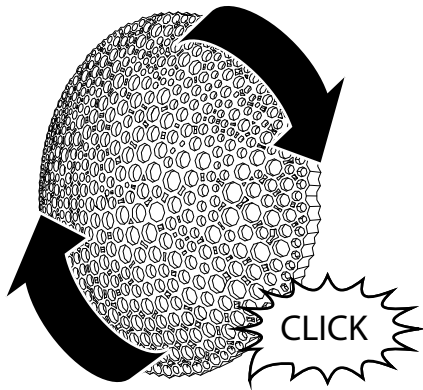

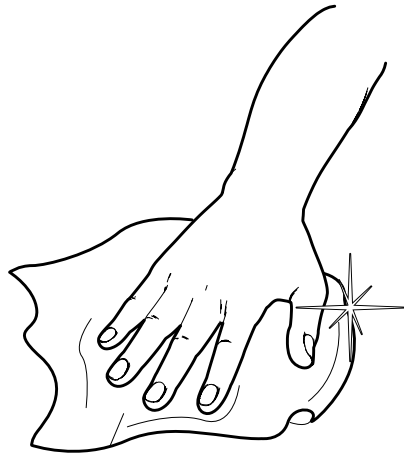
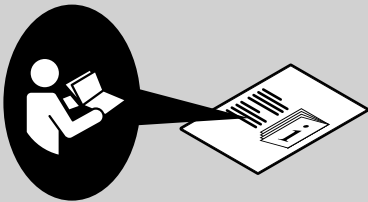
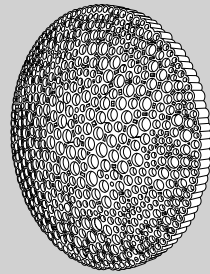
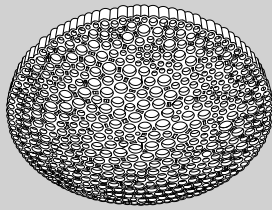

Artemide®

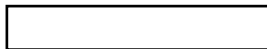

Artemide

via Bergamo, 18
20010 Pregnana M.se (MI)
ITALIA

tel. +39 02 935 181
fax +39 02 935 90 254
fax +39 02 935 90 496

www.artemide.com

VAT IT00846890150

cod. Y513000832B