

PHILIPS

Capricorn

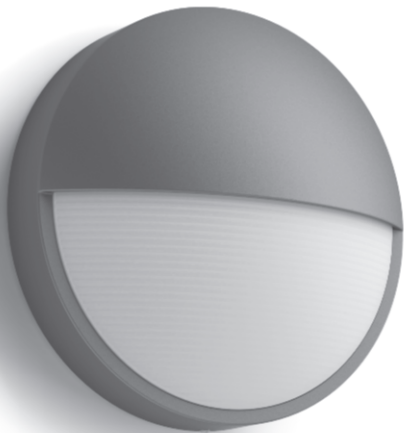

User manual
Benutzerhandbuch
Notice d'emploi
Manual de usuario
Manual do usuário
Manuale d'uso
Gebruiksaanwijzing

Incl.

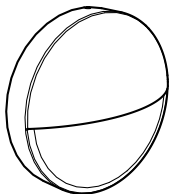

Excl.

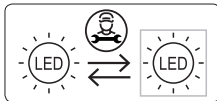
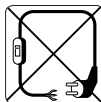
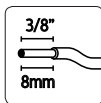
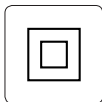
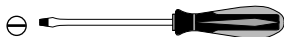
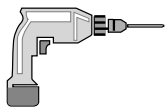

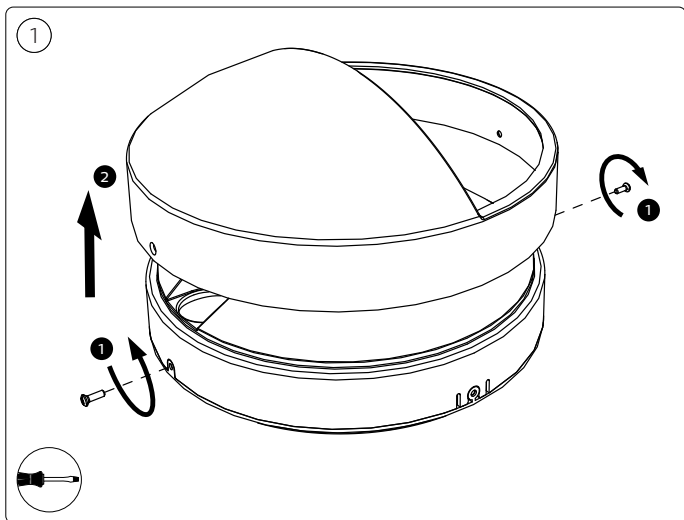
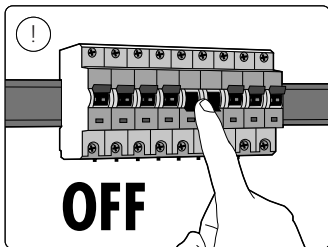
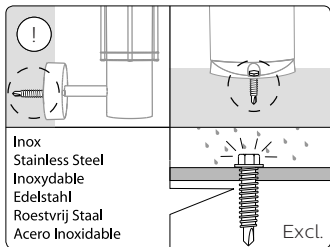

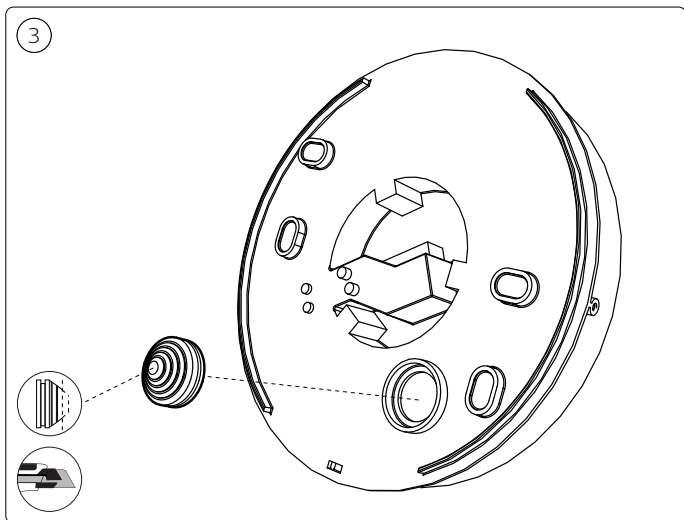
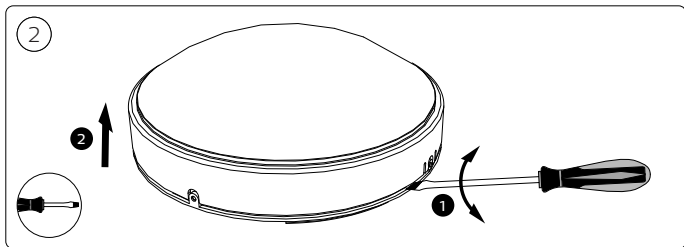

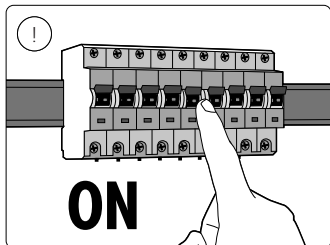
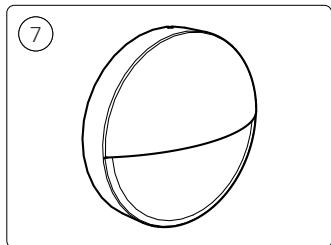
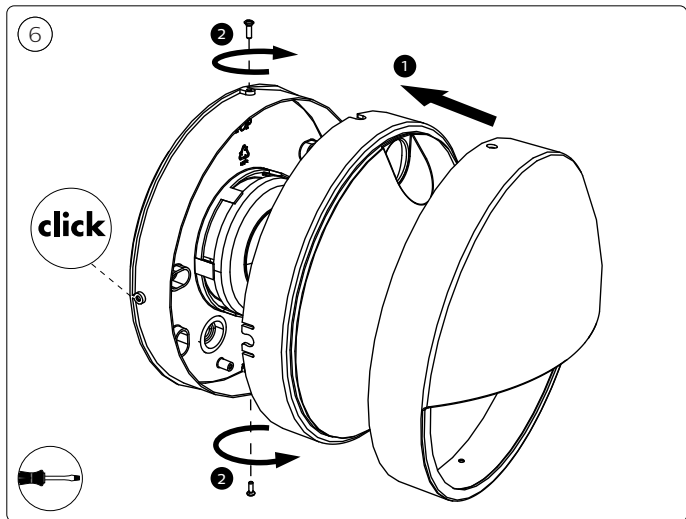



Signify
I.B.R.S. / C.C.R.I. Numéro 10461
5600 VB Eindhoven,
the Netherlands
☎00800-74454775

© 2021 Signify Holding
All rights reserved

www.philips.com/lighting

16455/**/16
4404 029 00663
Last update: 06/2021