



# Ledtube R

## Daniel López

**marset**



**Ledtube R**

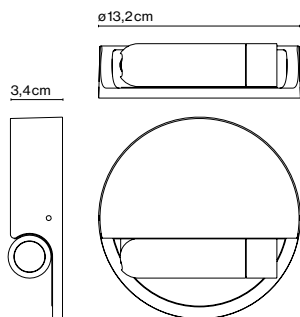

**Ledtube R**

LED 3W 700mA 2700K 150lm  
(included)

Injected aluminium structure and a frontal piece of transparent polycarbonate. Incorporated press button to switch on or off when folded away.

- Aluminium
- White (Ral 9003)
- Black (Ral 9005)
- Bronze

- [Download](#) Assembly Instructions
- [Download](#) 2D
- [Download](#) 3D
- [Download](#) Energy label

**Range**



info@marset.com  
www.marset.com

The orientable wall lamp is easy to use as the light turns on automatically when the Ledtube is opened, and turns off when it is closed.