

DUNBAR 100 LED

astro

GENERAL

LOCATION:	Exterior
CLASS:	CE (Class I)
IP RATING:	IP65
BATHROOM ZONE:	Zone 1, 2, 3
DRIVER REQUIRED:	No
INSTALLATION ORIENTATION:	Wall Mount - Down or Uplight
MAIN MATERIAL:	Metal - Aluminium
DIMENSIONS (mm):	H:100 W: 80 D:100
CUT OUT HOLE (mm):	-
RECESS DEPTH (mm):	-
FIRE RATING:	-
CABLE LENGTH (mm):	-
GROSS WEIGHT (kg):	0.72

LAMP

LIGHT SOURCE:	High Powered LED
WATTAGE:	3.7W
LAMP INCLUDED:	Yes (Integral)
MAXIMUM LAMP LENGTH (mm):	-
LUMINOUS FLUX (lm):	64
COLOUR TEMP (K):	3000
CRI (Ra):	80
MACADAM ELLIPSE:	3-Step
TILT ADJUSTABLE ANGLE (°):	-
ROTATION ADJUSTABLE ANGLE (°):	-
LIFETIME (hrs):	60000
BEAM ANGLE (°):	To Be Advised

ELECTRICAL

SWITCHED:	No
DIMMABLE:	No
DIMMING METHOD:	-
SUPPLY FREQUENCY (Hz):	50/60
DRIVER/BALLAST VOLTAGE (V):	220-240
DRIVER LIFETIME (hrs):	60000
EFFICACY (lm/W):	17

ADDITIONAL INFORMATION:

SHADE INCLUDED:	-
SHADE/DIFFUSER MATERIAL:	Glass
SHADE/DIFFUSER FINISH	Clear
F MARK:	Suitable for mounting on flammable materials



CODE: 1384001
FINISH: TEXTURED WHITE



CODE: 1384003
FINISH: TEXTURED BLACK



CODE: 1384022
FINISH: TEXTURED GREY

TO MAINTAIN THIS PRODUCT TO ITS BEST CONDITION, PLEASE VIEW OUR CARE AND CLEANING GUIDE ON THE SUPPORT SECTION OF THE ASTRO WEBSITE.

Pour entretenir au mieux ce produit, veuillez consulter notre guide d'entretien et de nettoyage, dans la rubrique d'aide sur le site Web d'Astro.

Um dieses Produkt im besten Zustand zu erhalten, beachten Sie bitte unseren Leitfaden zu Pflege und Reinigung im Abschnitt „Support“ auf der Astro-Website.

Per mantenere questo prodotto nelle sue migliori condizioni, consultare la nostra guida per la manutenzione e la pulizia nella sezione dedicata all'assistenza del sito Web Astro.

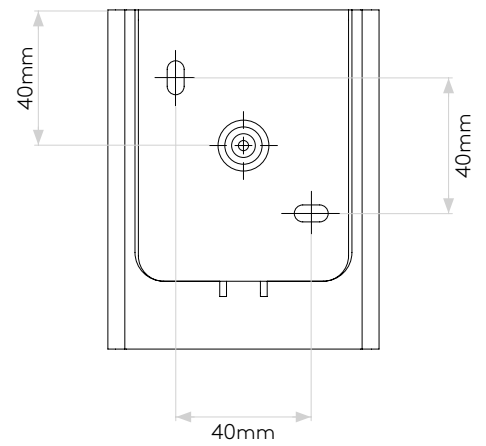
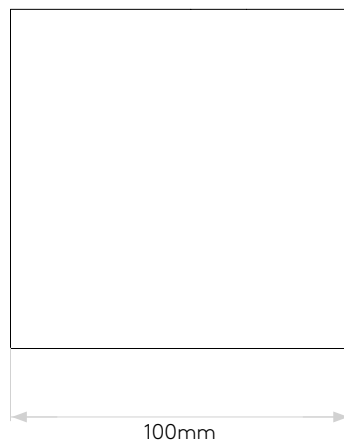
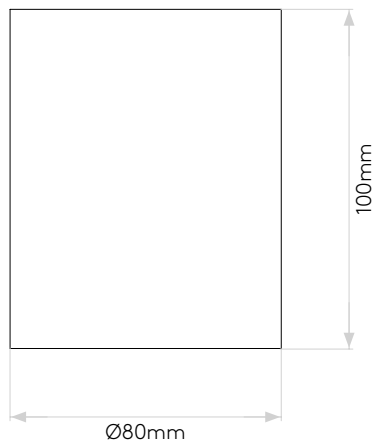
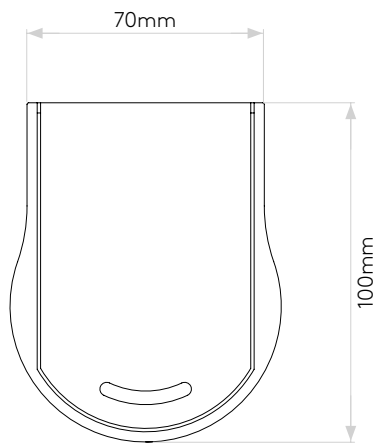

Please note that some dimensions may vary slightly due to manufacturing tolerances, this includes cable entry and fixing holes

Veillez noter que certaines dimensions peuvent varier légèrement en raison des tolérances de fabrication, y compris l'entrée de câble et les trous de fixation.

Bitte beachten Sie, dass die Maße Fertigungstoleranzen unterliegen und daher in geringem Umfang von der angegebenen Größe abweichen können. Dies gilt auch für Kabeleingänge und Befestigungslöcher.

Si prega notare che possono esserci piccole variazioni in alcune dimensioni dovute alle tolleranze di produzione, queste includono l'ingresso del cavo e i fori di fissaggio.