

FLOS

F021B34A001 White

Outgraze 50 L 1200 mm Non Dimmable White

Designed by FLOS Outdoor



Integrated 220/240V power supply. Installation brackets, to be ordered separately.
Extra clear transparent glass, excluding the DIFFUSE version with sandblasted glass.
SMART version available upon request (power 18,5W - flux -30% lm).

Are you a professional and your project needs consulting and support?

[BOOK AN APPOINTMENT](#)

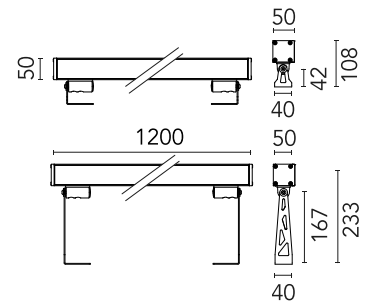

Main specifications

Mounting	Ceiling and wall surface
Environments	Outdoor wet location
LED type	Power LED
Lamp category	LED
Iicos	No
Power (W)	27
System flux (lm)	2821

Physical

Colour	White
Trim	No
Orientation	Adjustable
Transversal tilting (°)	180
Length (mm)	1200
Net weight (kg)	4.31
IP internal	66

Download

[Mounting instructions](#) ZIP

Photometric Files

[LDT / IES](#) ZIP

Technical Drawings

[2D](#) ZIP

[3D](#) ZIP

[Bim](#) ZIP



Schematic light drawing

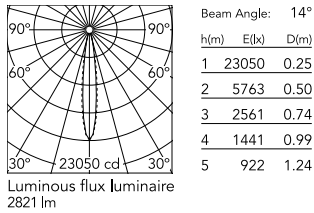

Photometric

Lighting type	Direct
Light distribution	Symmetric
CCT (K)	3000
CRI>	80
Beam angle C0-180 (°)	13
Beam angle C90-270 (°)	13

Electrical

Insulation class	I
Frequency (Hz)	50-60
Main voltage (Vac)	220-240
Driver	Integrated
Dimmable	No
Dimming type	Non Dimmable
Emergency type	No

Ecodesign and Energy Labelling

This product contains a light source of energy efficiency class E



Replaceable (LED only) light source by a professional



Replaceable control gear by a professional

Notes

We recommend using a connection system with a degree of protection greater than or equal to the degree of protection of the luminaire.

During the installation and the maintenance of the fixtures it is important to be careful and avoid damages on the paint coating.

Damages on the coating exposed to outdoor conditions or water, could cause corrosion.

Chemical substances affect the anticorrosion covering protection.

For LED fixtures, there is evidence that most of the damages are connected to electrical effects related to the insulations, which cause destructive electrical discharges

These effects are frequently caused by:

- over voltage coming from the mains' network where fixture is connected.
- electrostatic discharge (ESD) coming from the environment.

The use of a protective device against the overvoltage on the electrical installation is warmly suggest this helps to reduce the intensity of some of these phenomenon and prevent irreversible damages. The selection of the type of device to be used must be adjust on the electrical plant.

Accessories & Power Supply



REQUIRED
Accessory

F1204001

One pair of long brackets L 200 mm. White



REQUIRED
Accessory

F1203001

One pair of short brackets L 80 mm. White



REQUIRED
Accessory

F021Z010000

Plug&play connector 4 poles



REQUIRED
Accessory

F021Z030000

4-pole plug&play connector + 3-pole cable, 5000 mm length.



REQUIRED
Accessory

F990C00A000

2 way terminal block 4 poles IP68 H20 stop. (ø5,5÷12mm cable)



REQUIRED
Accessory

F990C010000

3/4 way terminal block 4 poles IP68 H20 stop. (ø5,5÷12mm cable)