

VENN 1.0

17-02-2016

1.0

LED (38W) | 220-240VAC | 50-60Hz | PCB3-step | phase-cut dim

CE IP20 960°C 10.3m P

3000K | >80CRI | 2500lm

White texture

149184W4

Black texture

149184B4



①

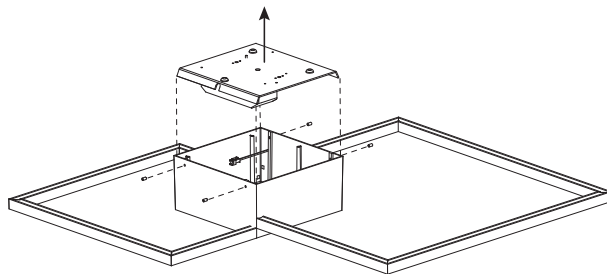

④

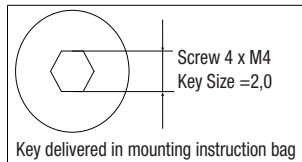
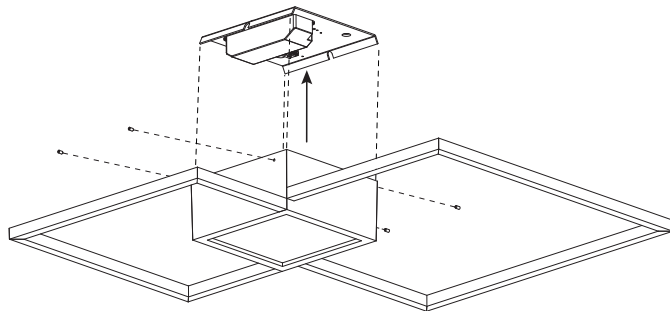

②

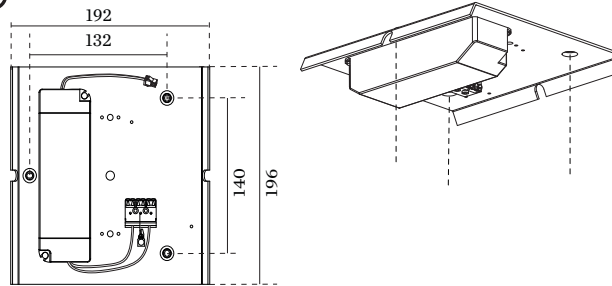

⑤

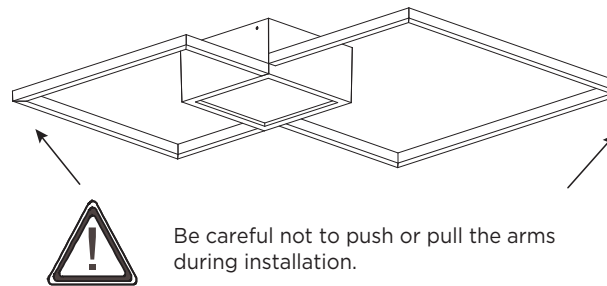

DIMENSIONS

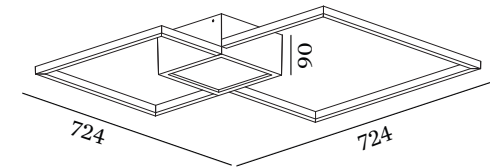

MOUNTING PLATE FIXATION

- ① Remove the mounting plate.
- ② Fixate the mounting plate to the wall/ceiling with screws.

POWER CONNECTION

- ③ Connect the terminal block.

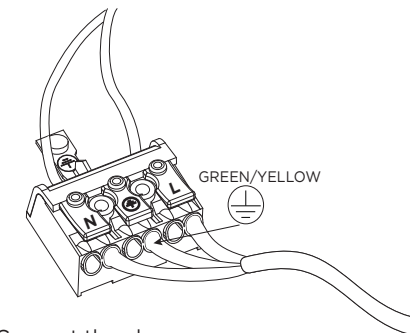

Connect the plugs.

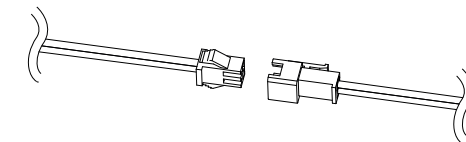

- ④ Fixate the lamp base back to the mounting plate.
- ⑤ Complete



WEVER & DUCRÉ
LIGHTING

www.weverducre.com

INSTALLATION
INSTRUCTIONS
PAGE 1/2

VENN 1.0

DETAILED MOUNTING INSTRUCTION
17-02-2016

DETAILED DIMENSIONS VENN:

