

# Smart Kup 82 IP LED<900L GE

124721XX

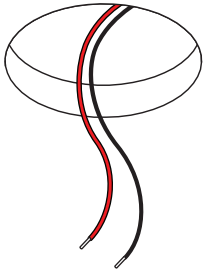

Drive Current (mA)	Forward Voltage		Power (W)
	min (Vf)	max (Vf)	
350	16,5	19,2	6,2
500	17,1	19,8	9,2
For serial connection, respect polarity!			
⊕ RED		⊖ BLACK	

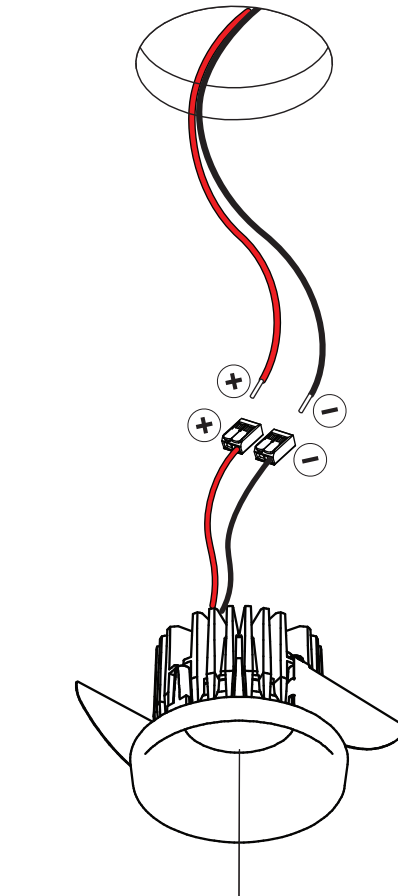
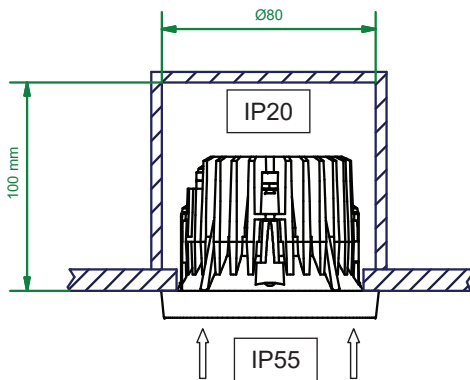
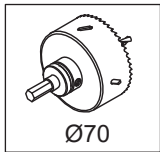

Replace protective shield when broken. The luminaire shall only be used complete with its protective shield. Reference number: 1010754

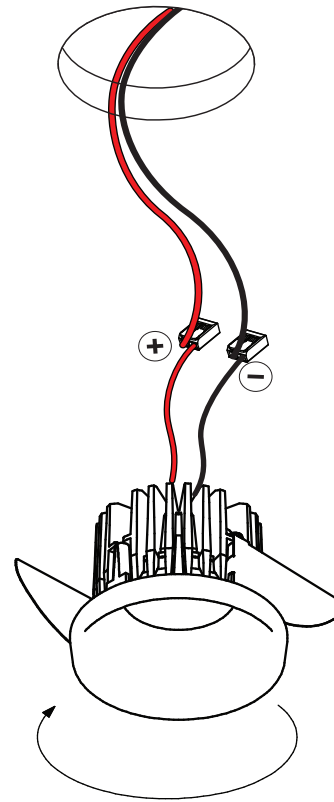

install : Twist clockwise  
 uninstall : Twist counterclockwise

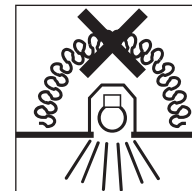

The light source contained in this luminaire shall only be replaced by the manufacturer or his service agent or a similar qualified person

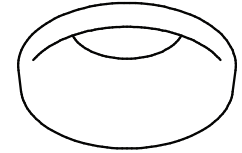

**CHECK DIP-SWITCHES ON DRIVER**

ON  
 OFF 1 2 3 4 5 6

check dipswitch settings on driver  
 Push Dim max 5 drivers on 1 push button

Drivers:  
 see driver matrix - latest version on website  
[www.supermodular.com](http://www.supermodular.com) or check sales contact

