

FLOS

F021B27D012 Forest Green

Outgraze 50 L 900 mm Dimmable DALI Forest Green

Designed by FLOS Outdoor



Integrated 120/240V power supply. Installation brackets, to be ordered separately.
Extra clear transparent glass, excluding the DIFFUSE version with sandblasted glass.
SMART dimmable DALI version available upon request (power 11W - flux -50% lm).
1-10V dimmable version upon request.

Are you a professional and your project needs consulting and support?

BOOK AN APPOINTMENT

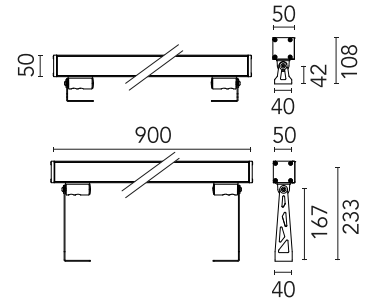

Main specifications

| | |
|------------------|--------------------------|
| Mounting | Ceiling and wall surface |
| Environments | Outdoor wet location |
| LED type | Power LED |
| Lamp category | LED |
| Ilcos | No |
| Power (W) | 20 |
| System flux (lm) | 2054 |

Physical

| | |
|-------------------------|--------------|
| Colour | Forest Green |
| Trim | No |
| Orientation | Adjustable |
| Transversal tilting (°) | 180 |
| Length (mm) | 900 |
| Net weight (kg) | 3.30 |
| IP internal | 66 |

Download

Mounting instructions [ZIP](#)

Photometric Files

LDT / IES [ZIP](#)

Technical Drawings

2D [ZIP](#)

3D [ZIP](#)

[Bim](#) [ZIP](#)



Schematic light drawing

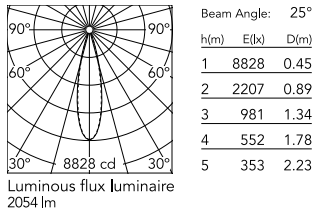

Photometric

| | |
|------------------------|-----------|
| Lighting type | Direct |
| Light distribution | Symmetric |
| CCT (K) | 2700 |
| CRI> | 80 |
| Beam angle C0-180 (°) | 29 |
| Beam angle C90-270 (°) | 29 |

Electrical

| | |
|--------------------|-----------------|
| Insulation class | I |
| Frequency (Hz) | 50-60 |
| Main voltage (Vac) | 120-240 |
| Driver | Integrated |
| Dimmable | Yes |
| Dimming type | Dimmable DALI 1 |
| Emergency type | No |

Ecodesign and Energy Labelling

This product contains a light source of energy efficiency class E



Replaceable (LED only) light source by a professional



Replaceable control gear by a professional

Notes

We recommend using a connection system with a degree of protection greater than or equal to the degree of protection of the luminaire.

During the installation and the maintenance of the fixtures it is important to be careful and avoid damages on the paint coating.

Damages on the coating exposed to outdoor conditions or water, could cause corrosion.

Chemical substances affect the anticorrosion covering protection.

For LED fixtures, there is evidence that most of the damages are connected to electrical effects related to the insulations, which cause destructive electrical discharges

These effects are frequently caused by:

- over voltage coming from the mains' network where fixture is connected.
- electrostatic discharge (ESD) coming from the environment.

The use of a protective device against the overvoltage on the electrical installation is warmly suggest this helps to reduce the intensity of some of these phenomenon and prevent irreversible damages. The selection of the type of device to be used must be adjust on the electrical plant.

Accessories & Power Supply



REQUIRED
Accessory

F021Z040000

Plug&play connector 5 poles



REQUIRED
Accessory

F021Z060000

5-pole plug&play connector + 5-pole cable, 5000 mm length.



REQUIRED
Accessory

F990C030000

4 way junction box 5 poles IP68 (6-14 mm cables)



REQUIRED
Accessory

F1203012

One pair of short brackets L 80 mm. Forest Green



REQUIRED
Accessory

F1204012

One pair of long brackets L 200 mm. Forest Green