

Smart Surface Tubed 48 track 48V 1x LED GI

129040XX_129041XX

POWER SUPPLY OFF

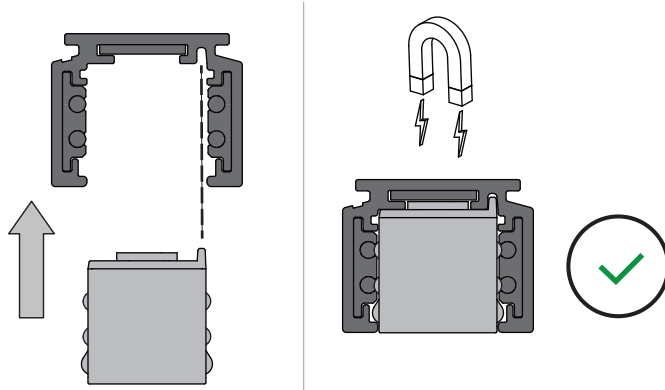
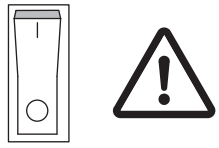

POWER SUPPLY ON

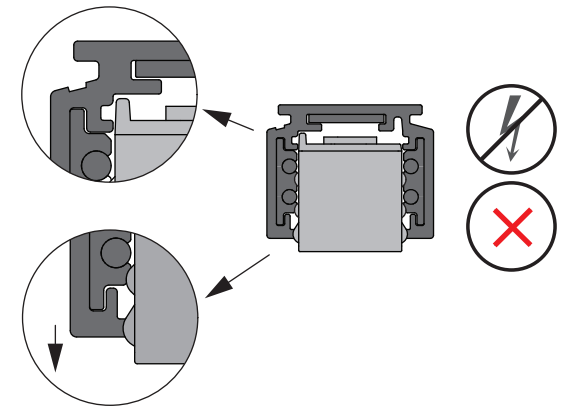

POWER SUPPLY OFF

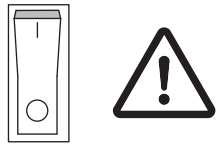

DRIVER SET TO 500mA

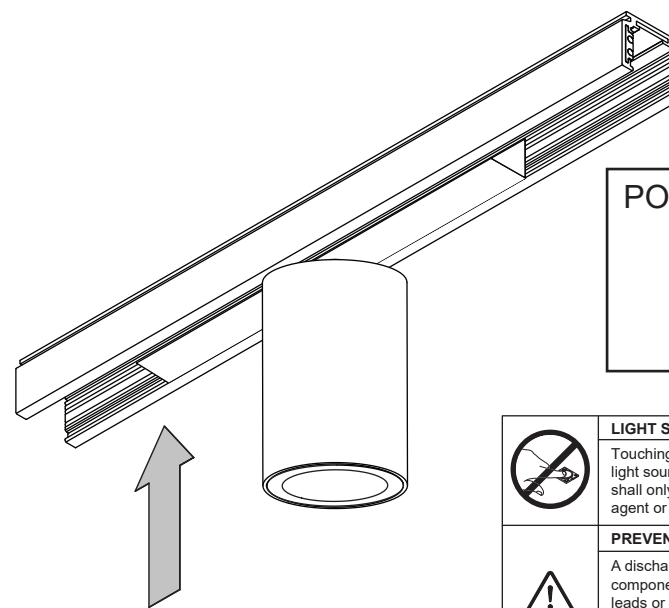
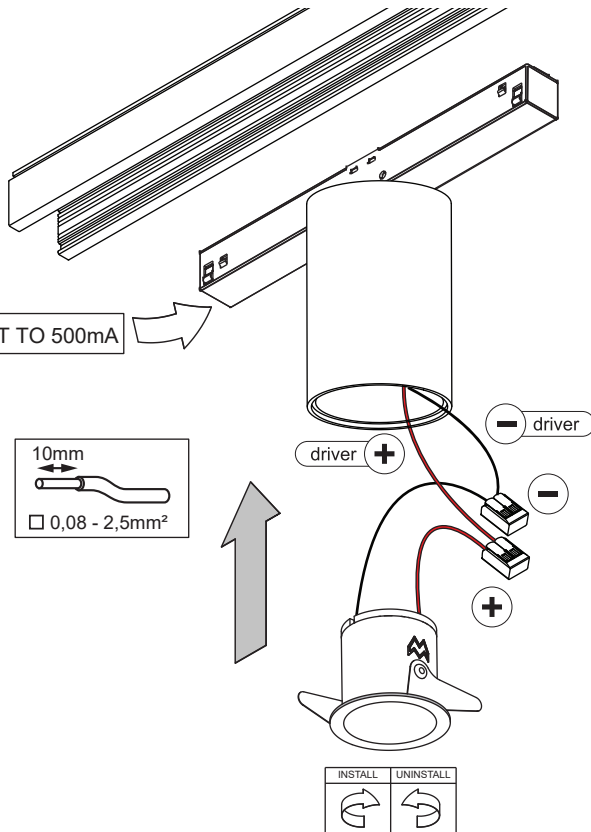

POWER SUPPLY ON



	LIGHT SOURCE - DO NOT TOUCH LED Touching the LED can result in permanent damage of the light source. The light source contained in this luminaire shall only be replaced by the manufacturer or his service agent or a similar qualified person.
	PREVENTING ELECTROSTATIC DAMAGE A discharge of static electricity may damage sensitive components. Always be properly grounded when touching leads or circuitry inside the luminaire. Use a wrist strap connected by a ground cord to the housing. Avoid touching the light sources with bare hands.

DRIVERS & ACCESSORIES

For latest version of driver matrix and available accessories check www.supermodular.com or connect with your sales contact.

