

Epoque, Cyclical *Light.*

design Stefano Papi & Saviz Yaghmai
terzani.com





TERZANI
LA LUCE PENSATA



Type |
Suspension

Materials |
Brass chains and metal
structure plated as below



Finishes | Code

-  Nickel
0G91S E7 C8
-  Black Nickel
0G91S E9 C8
-  Bronze
0G91S F7 C8
-  Gold
0G91S L6 C8

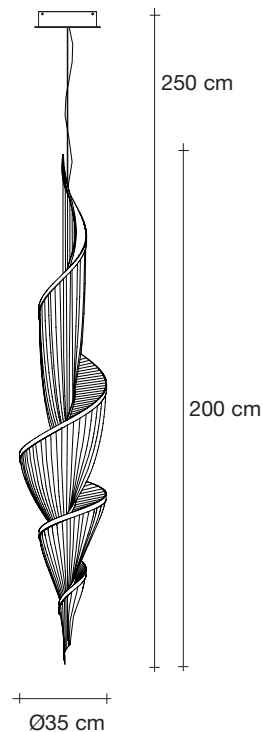
Body |



Integrated Led |
230-240V ~ 50/60Hz

-  LED integrated
12 x 2,1W 2880 lm 3000K
or optional 2700K
-  Dimmable with 1-10V, PUSH
and Dali systems only

Canopy |

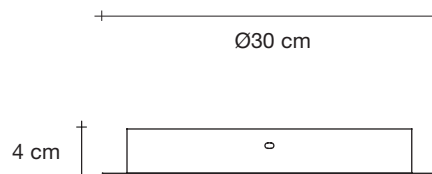
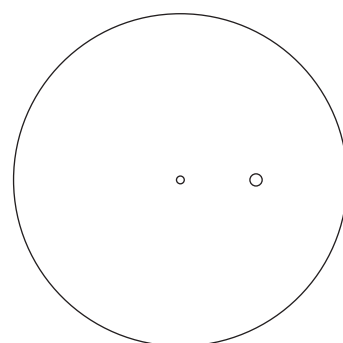

Epoque is a light sculpture designed to study chiaroscuro and volumes. The result is a modern expression of these Renaissance-era techniques in a stunning chandelier. Composed of curved, organic lines, Epoque's frame is made of flexible and durable brass metal, suspended by nickel metal chains. Two bands of metal, a central elongated section and an external band of wide arcs, allows the light to envelop a room in reflections of soft light. Epoque has attracted attention from those in the design community with discerning tastes. Epoque is available in nickel, black nickel and gold finish. Design Stefano Papi & Saviz Yaghmai.



55



14,5



196cm x 50cm x 71cm

Epoque, Cyclical Light.

design Stefano Papi & Saviz Yaghmai
terzani.com





TERZANI
LA LUCE PENSATA



Type |
Suspension

Materials |
Brass chains and metal
structure plated as below



Finishes | Code

-  Nickel
OG90S E7 C8
-  Black Nickel
OG90S E9 C8
-  Bronze
OG90S F7 C8
-  Gold plated
OG90S L6 C8

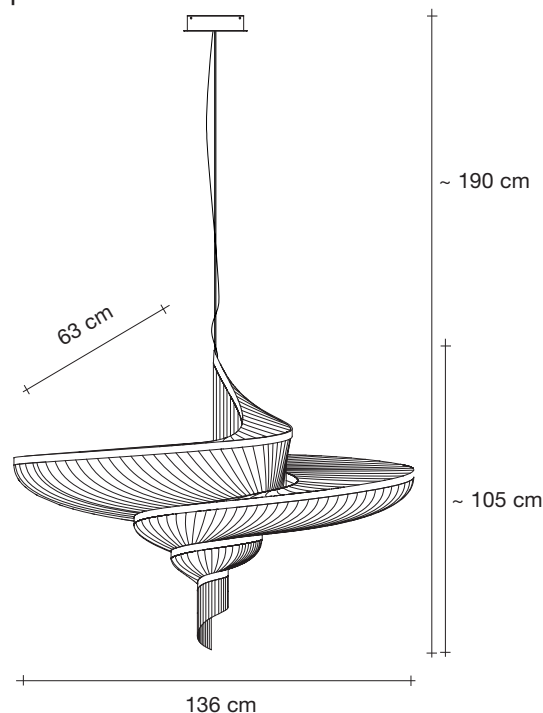
Body |



Integrated Led |
230-240V ~ 50/60Hz

-  LED integrated
20 x 2,1W 4800 lm 3000K
or optional 2700K
-  Dimmable with PUSH
and Dali system only

Canopy |

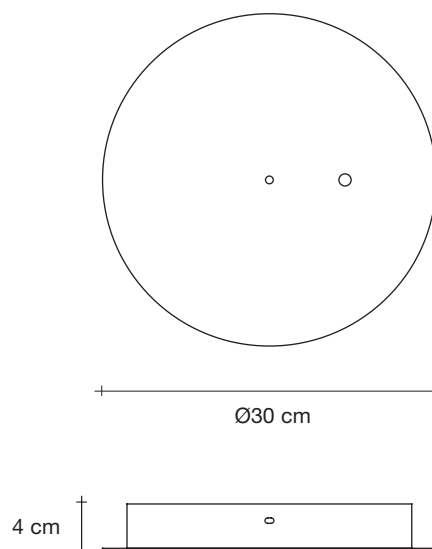

Epoque is a light sculpture designed to study chiaroscuro and volumes. The result is a modern expression of these Renaissance-era techniques in a stunning chandelier. Composed of curved, organic lines, Epoque's frame is made of flexible and durable brass metal, suspended by nickel metal chains. Two bands of metal, a central elongated section and an external band of wide arcs, allows the light to envelop a room in reflections of soft light. Epoque has attracted attention from those in the design community with discerning tastes. Epoque is available in nickel, black nickel and gold finish. Design Stefano Papi & Saviz Yaghmai.



96



36



155cm x 95cm x 139cm