

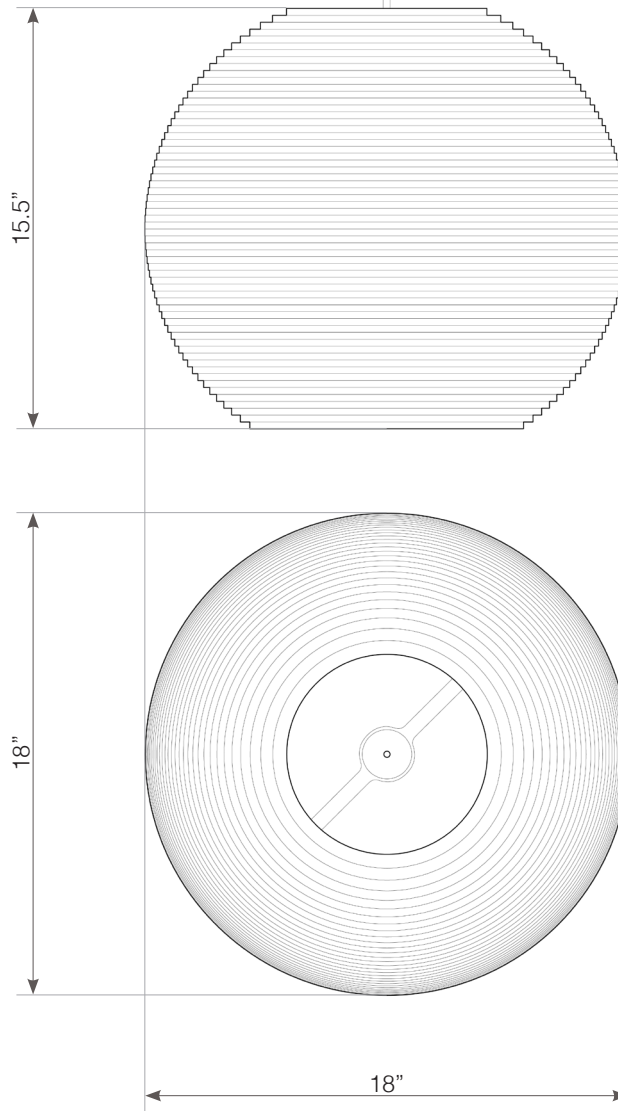













3220 1st ave s #400, seattle, wa 98134 | 206.420.3912
seattle@graypants.com | graypants.com



MOON_18

-  100W maximum incandescent A19 E26 (120V)
-  GU24 twist lock sockets available (120V/277V)
-  32W maximum fluorescent GX24Q (120V/277V)¹

Equivalent W dimmable LED bulbs compatible. 2700K color temperature recommended.

-  recycled cardboard
-  proudly designed and made in seattle | usa
-  responsible handmade quality ²
-  nontoxic fire retardant treated ³
-  compressed air recommended cleaning
-  use in dry location only
-  designed to recycle
-  patent pending



hardwired cord set + ceiling canopy

INCLUDES 8' CORD AND POWDER COATED STEEL CANOPY (5" FOR E26/GU24, 8" FOR GX24Q). CORDS AND MATCHING CANOPIES ARE AVAILABLE IN BLACK OR WHITE. CUSTOM CORD LENGTHS ARE AVAILABLE FOR AN ADDITIONAL CHARGE.

¹ Dimmable option available. Graypants does not offer a warranty for dimming ballasts.

² Scraplight shades are non-toxic and are handmade using responsible, low-impact practices. Because all Scraplights are handmade, dimensions may vary slightly.

³ Scraplight shades are treated with No-Burn® fire retardant. All No-Burn® spray coatings are GREEN with low to zero VOCs, and all carry a Class-A fire rating.